

Chapter 9

The Disklavier & Computers

Creating music with computers used to be a job for professionals only. However, in this age of multimedia, and with many people owning personal computers, almost anyone can enjoy creating music using computers.

General MIDI and Standard MIDI File (SMF) formats supported by the Disklavier are formats common to most computers and MIDI instruments, so you can, for example, use your computer to download SMF data from the Internet and play it on the Disklavier.

The Disklavier can be connected to a computer using the TO HOST connector. It can also be connected via MIDI IN/OUT connectors, but in this case a separate MIDI interface is required. The TO HOST connector allows you to connect your Disklavier to a computer without the MIDI interface.

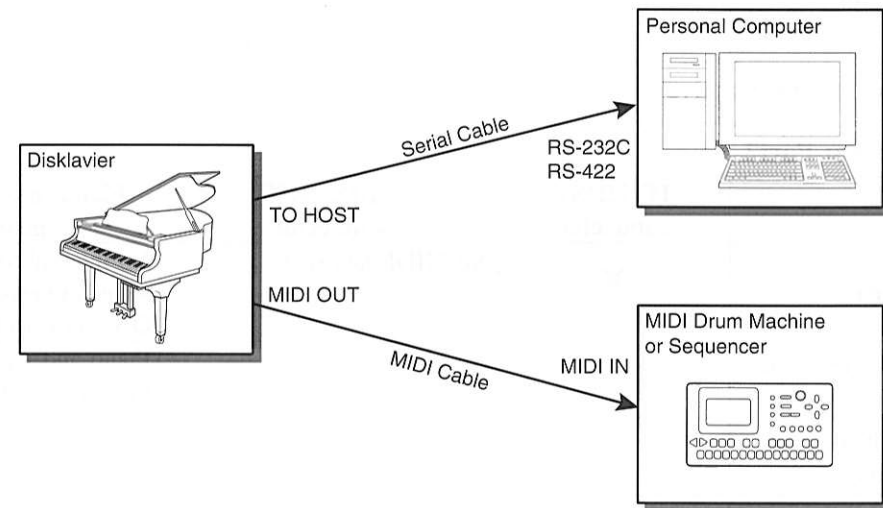

Note: For the computer setups described in this chapter, it is recommended that you connect your computer to the TO HOST connector and set the HOST SELECT switch to PC1, PC2, or MAC depending on your computer type, so that the Disklavier functions properly. See "Setting the HOST SELECT Switch" on page 83.

Connecting to a Computer

Specifically, Apple Macintosh, IBM PC/AT, and NEC PC-9801/9821 series computers can be directly connected to the Disklavier. Connect the RS-232C or RS-422 connector on your computer to the TO HOST connector on the Control Unit using the specified cables shown below (available separately). Also refer to your computer's operating manual, and make the connection properly.

Your computer may also require a serial port driver for this function. This software is used for controlling the MIDI interface. For further information, please consult your Yamaha dealer.

Note: Be sure to turn the computer and Disklavier power switches off before making the connections and setting the HOST SELECT switch.

Connecting to an Apple Macintosh Series Computer

Use a standard Macintosh 8-pin system peripheral cable.

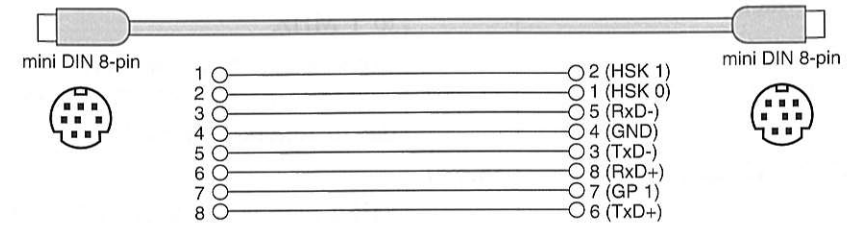

Connecting to an NEC PC-9801/9821 Series Computer

Use a standard 8-pin MINI DIN → 25-pin D-SUB cross cable.

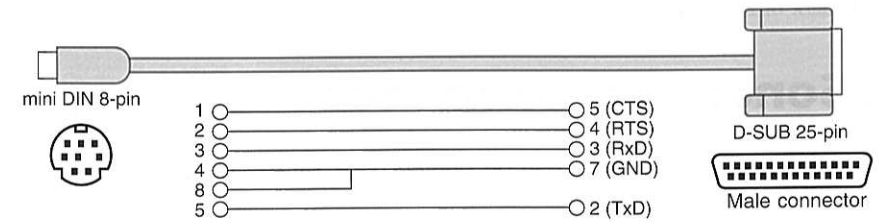

Connecting to an IBM PC/AT Series Computer

(a) Use a standard 8-pin MINI DIN → 9-pin D-SUB cross cable.

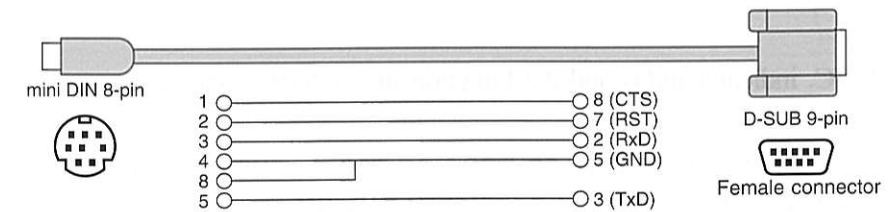

(b) Use a standard 8-pin MINI DIN → 25-pin D-SUB cross cable.

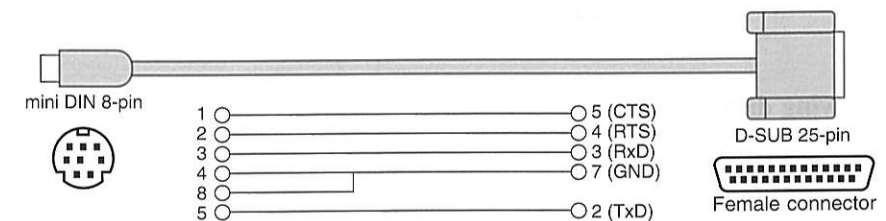

Setting the HOST SELECT Switch

Set the HOST SELECT switch on the rear panel of the Control Unit according to your computer type.

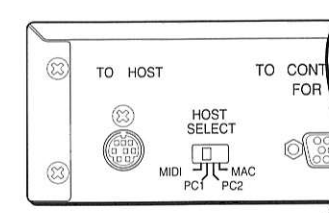

HOST SELECT	Computer type	Baud rate	Remarks
MAC	Apple Macintosh series	31,250	On the computer side, set the clock speed to 1 MHz.
PC1	NEC PC-9801/9821 series	31,250	Some software require the HOST SELECT switch to be set to PC2 (38,400 bps) in order to function properly.
PC2	IBM PC/AT series	38,400	
MIDI	General MIDI equipment	31,250	MIDI data is sent/received via MIDI OUT/IN connectors, and not the TO HOST connector.

* Apple and Macintosh are trade marks of Apple Computer, Inc.

* IBM PC/AT is a trademark of International Business Machines Corporation.

* PC-9801/9821 is a trademark of NEC Corporation.

Playing Back Songs in a Computer

Songs created and stored in your computer system can be played back by the Disklavier.

1 Press the [FUNC.] button.

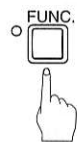

The FUNC. indicator lights and the Function menu display appears.

2 Use the [↔] cursor button to position the cursor next to the MIDI Setup option, then press the [ENTER] button.

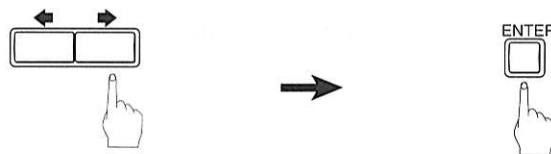

The following display appears.

```

>Piano Part *MIDI Out
*Remote      *Local
  
```

3 With the cursor next to the Piano Part option, press the [ENTER] button.



The following display appears.

```

>Piano Rcv Ch=01
>Delay In(500ms)=ON
  
```

4 With the cursor next to the Piano Rcv Ch parameter, use the [-/NO] and [+/YES] buttons to select the channel for the piano part.

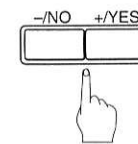

The selected channel will be played by the Disklavier piano, and the other channels by the internal XG tone generator. See “Receiving Data from a MIDI Sequencer” on page 74 for details on MIDI channels.

5 Press the [↔] cursor button to position the cursor next to the Delay In parameter, then use the [-/NO] and [+/YES] buttons to set it.

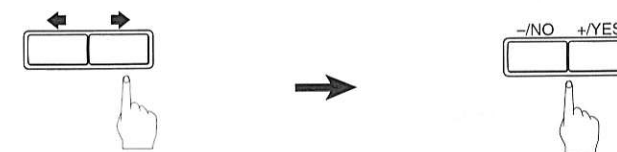

```

>Piano Rcv Ch=1+2
#Delay In(500ms)=ON
  
```

Option	Description
ON	A delay of 500 ms is applied to all incoming MIDI data from the computer so that the timing of the piano and the internal XG tone generator match for smooth playback.
OFF	The delay is not applied, and the piano is played in “real time”. However, playback will not be smooth. When Piano Rcv Ch is set to ##, all channels are played by the internal XG tone generator, so Delay In is automatically set to OFF.

For more information on the 500 ms delay function, see “Controlling the Disklavier in Real Time” on page 76.

6 Press the [FUNC.] button or the [STOP] button to return to the normal display.

Recording Songs to a Computer (Sequencer)

You can record keyboard and pedal data onto a computer.

1 Press the [FUNC.] button.



2

Press the [↔] cursor button to position the ▸ cursor next to the MIDI Setup option, then press the [ENTER] button.

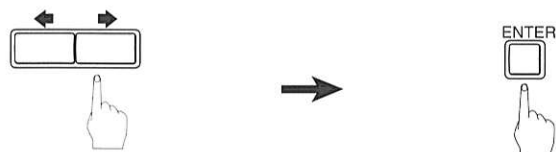

The following display appears.

```
▶Piano Part *MIDI Out
*Remote      *Local
```

3

Press the [↔] cursor button to position the ▸ cursor next to the MIDI Out option, then press the [ENTER] button.

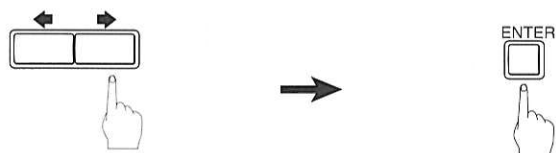

The following display appears.

```
▶MIDI Out=KBD Out
TO HOST =KBD Out →
```

→ See “Summary of the MIDI Out Parameter in a Computer Setup” on pages 89 and 90 for details on the MIDI Out parameter.

4

With the ▸ cursor next to the MIDI Out parameter, press the [↔] cursor button.

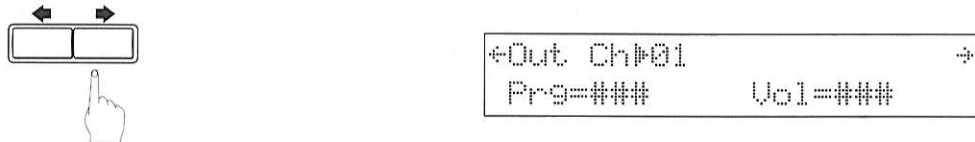

The “Out Ch” option is used to select the MIDI channel on which the Disklavier will transmit MIDI data. It can be set to OFF, MIDI channels 1 to 16, or HP.

Channel	Description
OFF	No data is sent to the MIDI instrument.
1 to 16	The Disklavier keyboard data and pedal data is sent on the selected channel.
HP	Keyboard data and on/off pedal data will be sent on channel 1, and continuous pedal data (half pedal) will be sent on channel 3. In this case the pedal data will be continuously variable (half pedal).

If you want to play the piano parts on the internal XG tone generator, set Piano Rcv Ch to ##. There will be no delay effect if all channels are monitored on the internal XG tone generator. See “Controlling the Disklavier in Real Time” on page 76 for details on the 500 ms delay effect.

To monitor all recording parts on the internal XG tone generator, set the “Echo Back” or “Patch Thru” options on the computer or sequencer to ON. See their operating manuals for details.

5

Press the [FUNC.] button or the [STOP] button to return to the normal display.

Playing Back More than 16 Channels

You can play back from a computer, song data that contains up to 32 channels by connecting the Disklavier’s TO HOST connector to the serial port on a computer and its MIDI OUT connector to a MIDI instrument. Using software corresponding to port signals, the 32 channels are sent to the Disklavier. The Disklavier plays channels 1 to 16 (port 1) and channels 17 to 32 (port 2) are output to an external MIDI instrument.

1

Press the [FUNC.] button.

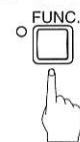

2

Press the [↔] cursor button to position the ▸ cursor next to the MIDI Setup option, then press the [ENTER] button.

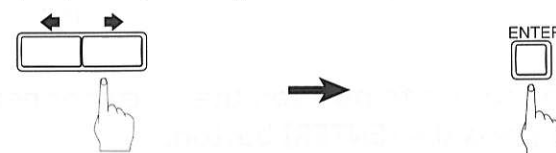

The following display appears.

```
▶Piano Part *MIDI Out
*Remote      *Local
```

3

Press the [↔] cursor button to position the ▸ cursor next to the MIDI Out option, then press the [ENTER] button.

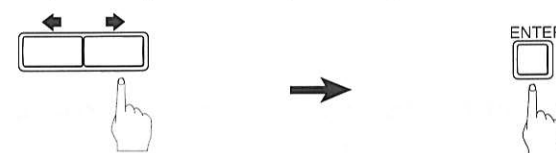

The following display appears.

```
▶MIDI Out=KBD Out
TO HOST =KBD Out →
```

→ See “Summary of the MIDI Out Parameter in a Computer Setup” on pages 89 and 90 for details on the MIDI Out parameter.

4

With the ▸ cursor next to the MIDI Out parameter, use the Dial or the [-/NO] and [+ /YES] buttons to select “Thru Port2”.

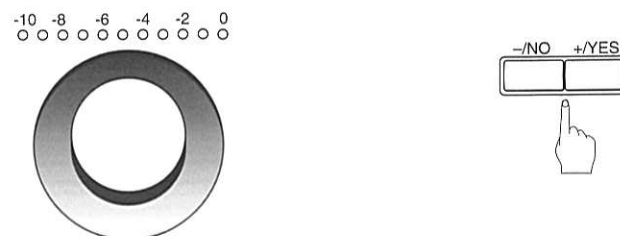

5

Press the [FUNC.] button or the [STOP] button to return to the normal display.

Temporarily Disactivating the Internal XG Tone Generator

When you are using the Disklavier's internal XG tone generator from a computer and do not want any interference from the keyboard, you can set the Disklavier so that the tone generator and keyboard are temporarily disconnected. Even when the Voice function is on, no sound is produced from the piano. It will sound only by messages are received through the MIDI IN or TO HOST connectors.

1

Press the [FUNC.] button.



The FUNC. indicator lights and the Function menu display appears.

2

Press the [↔] cursor button to position the cursor next to the MIDI Setup option, then press the [ENTER] button.

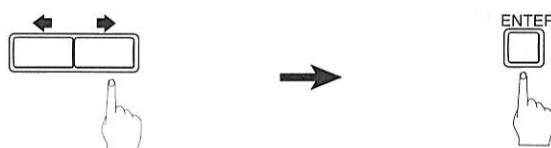

The following display appears.

```
*Piano Part *MIDI Out
*Remote    *Local
```

3

Press the [↔] cursor button to position the cursor next to the Local option, then press the [ENTER] button.

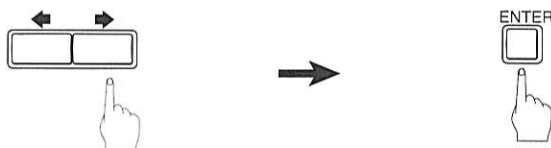

4

Use the [-/NO] and [+ /YES] buttons to set Local to OFF.

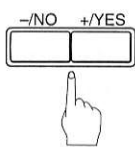

The following display appears.

```
*Local=OFF
(Not memorized!)
```

Note: The OFF setting remain in effect only until the Disklavier is switched off. The next time you switch on the Disklavier, the "Local" setting is returned to ON (default).

5

Press the [FUNC.] button or the [STOP] button to return to the normal display.

Summary of the MIDI Out Parameter in a Computer Setup

The following tables show the differences among the MIDI OUT settings (KBD Out, ESBL Out, Thru Port2) with the HOST SELECT switch set to PC1, PC2 or MAC.

MIDI OUT = KBD Out

Action	TO HOST connector	MIDI OUT connector	Piano/Internal XG tone generator
Play on keyboard	MIDI data sent if Out Ch ≠ OFF.	MIDI data sent if Out Ch ≠ OFF.	No internal tone generator sounds unless Voice button is ON and Local = ON.
Playback of ensemble song file	No MIDI data sent.	No MIDI data sent.	Piano and internal tone generator play normally.
MIDI data received from TO HOST connector	No MIDI data passed through except for pedal data. (See note.)	No MIDI data passed through except for pedal data. (See note.)	Piano and internal tone generator play normally; delay applied if Delay In = ON.
MIDI data received from MIDI IN connector	All MIDI data passed through without delay	No MIDI data passed through.	Piano and internal tone generator do not respond.

Note: When pedals are played (activated) by data, the depth of the pedals is read by the sensors and sent (KBD Out) via channels selected in the Out Ch setting (as, unlike the keyboard, the pedals cannot distinguish whether they are being activated by foot or by data).

Chapter 10

Resetting Your Disklavier

MIDI OUT = ESBL Out

Action	TO HOST connector	MIDI OUT connector	Piano/Internal XG tone generator
Play on keyboard	MIDI data sent if Out Ch \neq OFF.	No MIDI data sent unless Voice button in ON.	No internal tone generator sounds unless Voice button is ON and Local = ON.
Playback of ensemble song file	No MIDI data sent except for pedal data. (See note.)	All MIDI data sent except for piano parts (pedal always sent on piano channel); piano parts sent if PianoPart ESBL OUT = ON; if E-SEQ song, incremental pedals not sent on channel 3.	Piano and internal tone generator play normally.
MIDI data received from TO HOST connector	No MIDI data passed through except for pedal data. (See note.)	All MIDI data passed through; delay applied if Delay In = ON.	Piano and internal tone generator play normally; delay applied if Delay In = ON.
MIDI data received from MIDI IN connector	All MIDI data passed through without delay.	No MIDI data passed through.	Piano and internal tone generator do not respond.

Note: When pedals are played (activated) by data, the depth of the pedals is read by the sensors and sent (KBD Out) via channels selected in the Out Ch setting (as, unlike the keyboard, the pedals cannot distinguish whether they are being activated by foot or by data).

MIDI OUT = Thru Port2

Action	TO HOST connector	MIDI OUT connector	Piano/Internal XG tone generator
Play on keyboard	MIDI data sent if Out Ch \neq OFF.	No MIDI data sent.	No internal tone generator sounds unless Voice button is ON and Local = ON.
Playback of ensemble song file	No MIDI data sent except for pedal data. (See note.)	No MIDI data sent.	Piano and internal tone generator play normally.
MIDI data received from TO HOST connector	No MIDI data passed through except for pedal data. (See note.)	All MIDI data on channels 17-32 sent; delay applied if Delay In = ON	Piano and internal tone generator play channels 1-16 normally; delay applied if Delay In = ON.
MIDI data received from MIDI IN connector	All MIDI data passed through.	No MIDI data passed through.	Piano and internal tone generator do not respond.

Note: When pedals are played (activated) by data, the depth of the pedals is read by the sensors and sent (KBD Out) via channels selected in the Out Ch setting (as, unlike the keyboard, the pedals cannot distinguish whether they are being activated by foot or by data).

If you want to return your Disklavier to its initial factory settings, follow the Reset function below.

Resetting Your Disklavier

You can reset all settings, the Memory Disk, or both.

- 1 Press the [FUNC.] button.



The FUNC. indicator lights and the Function menu display appears.

- 2 Use the [↔] cursor button to position the cursor next to the Reset option, then press the [ENTER] button.



The following display appears.

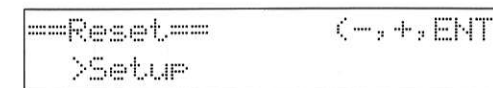

- 3 Use the Dial or the [-/NO] and [+ /YES] buttons to select the item that you want to reset. Then press the [ENTER] button.

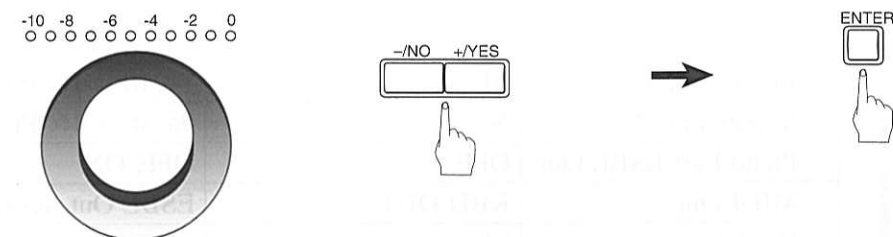

Option	Description
Setup	All settings (See next page.)
Memory Disk + Setup	Memory disk and all settings (SMF format; sample song included) (See also next page.)
Memory Disk	Memory disk only (SMF format; sample song included)

The following display appears.

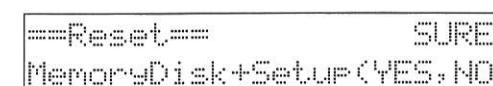

Press the [+ / YES] button to reset the settings.

If you do not want to reset the settings, press the [- / NO] button.

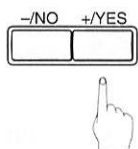

The following table lists the default settings for the items that can be reset.

Parameter	Default Setting	Options
General		
Volume	0	-10 - 0
Tempo	0	-50 - +20
Transpose	0	-24 - +24
Repeat	OFF	ALL, RPT, RND, A-B
Pedal Cancel	PD on	PDoff, PD on
Voice		
Voice	001	001 - 128
Vol	100	000 - 127
Metronome		
Click	ON	OFF, ON
Tempo	117	30 - 400
Beat	4/4	1/4 - 9/4
Pedal Count	OFF	OFF, ON
Auto Setup		
Auto Start	OFF	OFF, ON
Space Play	OFF	OFF, 1 - 300, STOP
M-Tune		
TG Master Tune	00	-50 - 00 - +50
BALANCE		
TG Master Balance	100	10 - 127
MIDI Setup		
Piano Rcv Ch	01	##, 01 - 16, 1+2, Prg, Prg(all)
Delay In (500 ms)	ON	ON, OFF
Import File L	01	##, 01 - 16, Prg, Prg(all)
Import File R	##	##, 01 - 16, Prg
Piano Part ESBL Out	OFF	OFF, ON
MIDI Out	KBD OUT	ESBL Out, KBD Out, Thru Port2
Out Ch	01	01 - 16
Split	OFF	OFF, A-1 - C-7
Trans L	00	-60 - 00 - +60
Trans R	00	-60 - 00 - +60
Remote Out	OFF	OFF, ON
Remote In	OFF	OFF, ON
Local	ON	OFF, ON

Chapter 11

Using the Optional Foot Switch/Controller

An optional Yamaha foot switch or foot controller can be used to operate various Disklavier functions.

Using a Start/Stop Foot Switch

Start/stop functions can be controlled using an optional Yamaha FC-4 or FC-5 foot switch.

The following table shows which functions can be controlled using the foot switch.

Current Mode	One Press	Press Again
STOP	PLAY	PAUSE
PAUSE	PLAY	PAUSE
RECORD PAUSE	START RECORD	PAUSE RECORD

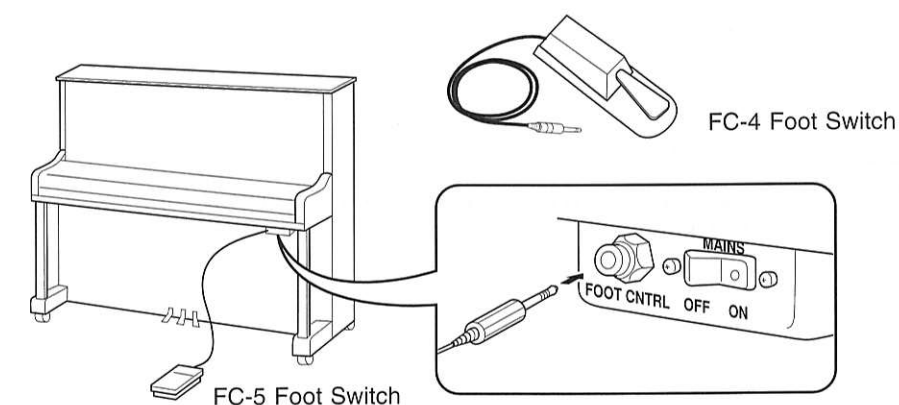

Using a Foot Controller to Control the Tempo

By connecting an optional Yamaha FC-7 controller pedal, the playback tempo can also be controlled.

The following table shows which functions can be controlled using the controller pedal.

Current Mode	Pedal Down	Pedal Up
STOP	PLAY	PAUSE
PAUSE	PLAY	PAUSE
PLAYBACK	PLAY (TEMPO 100%) See illustration below.	PAUSE See illustration below.
RECORD PAUSE	START RECORD	PAUSE RECORD

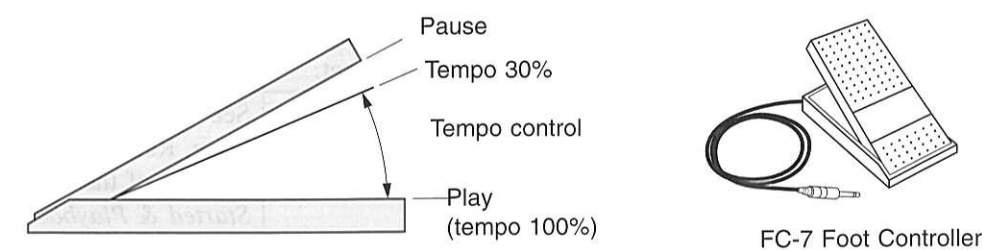

Chapter 12 Troubleshooting

If you are having difficulty operating your Disklavier, see if any of the symptoms listed below apply to your problem, then follow the recommended remedy.

Symptom	Remedy	Reference
Power		
The Disklavier cannot be powered on.	Make sure the power cord is connected to a suitable AC outlet.	See "Power On Procedure" on page 13 of the <i>Getting Started & Playback Manual</i> .
	Switch on the Disklavier's "MAINS" switch.	
	Switch on the Control Unit's "STANDBY-ON" switch.	
	If the Disklavier still cannot be powered up, disconnect it from the AC wall outlet, and consult your Disklavier dealer.	
Control Unit		
The Control Unit does not appear to work correctly.	Turn the power off, wait 5 seconds, then turn it back on.	
	If the problem remains, consult your Disklavier dealer.	
Remote Control		
You cannot control the Disklavier using the remote control.	Make sure that you are pointing the remote control at the Control Unit's remote control sensor.	See "Using the Remote Control" on page 15 of the <i>Getting Started & Playback Manual</i> .
	Make sure that you are within the remote control's specified operating range.	
	Make sure that the remote control's batteries have been installed correctly.	See "Installing Batteries in the Remote Control" on page 15 of the <i>Getting Started & Playback Manual</i> .
	Check the condition of the remote control's batteries.	See "Battery Replacement" on page 15 of the <i>Getting Started & Playback Manual</i> .
Playback		
None of the playback functions can be used.	Insert a Disklavier song disk into the disk drive.	
Songs are played back at the wrong tempo or in the wrong key.	Reset the tempo or transposition functions.	
	Once the tempo or transposition functions have been set, they will affect playback of all songs until another disk is inserted, or they are reset.	
Songs are not played back in the normal song order.	Check that the "RND" and "RPT" repeat functions are off.	See "All Song, Single Song, Random Repeat" on page 31 of the <i>Getting Started & Playback Manual</i> .

You selected a song using the remote control's number pad, but the last song on the disk is found.	If a song number higher than the last song number on the disk is specified, the last song will be found.	
A search time is specified using the remote control, but the end of the song is found.	If a time value higher than the total length of the song is specified, the end of the song will be found.	
	Increase the Disklavier's volume level.	
During playback, complex note trills and faint pianissimo passages are occasionally missed.	The Disklavier lowers the playback volume by reducing the force applied to each hammer. So for notes that are already quiet (pianissimo, etc.), when the playback volume is reduced there may not be enough force applied to a hammer for it to strike the strings.	
When you play the piano, the keys do not respond in the normal manner and the sound is very soft.	The Disklavier upright may be in "soft mode" (volume set between -7 and -10). Set volume to 0.	See "Adjusting the Volume" on page 26 in the <i>Getting Started & Playback Manual</i> .
The metronome does not sound during song playback.	Check that the song uses a measures and beats time format. If not, the metronome will not sound.	
Pedal		
The Disklavier upright's muffler pedal does not move during song playback.	Data for the Disklavier upright's muffler pedal is not recorded, so it will not move during playback.	
Your Disklavier upright is powered off and the soft pedal cannot be used.	Power on the Disklavier upright, then switch off the Control Unit's POWER switch first, then the MAINS switch.	See "Power Off Procedure" on page 14 of the <i>Getting Started & Playback Manual</i> .
	If the Disklavier upright's volume level is set to soft mode (soft pedal depressed) and the MAINS switch is switched off before the Control Unit's POWER switch, the soft pedal will remain depressed. Always switch off the Control Unit first, then the MAINS switch.	
During playback, the pedals do not operate.	Check that the pedal cancel function is not set to "PDoff".	See "Operating the Pedals Yourself" on page 41 of the <i>Getting Started & Playback Manual</i> .
Tone Generator (Ensemble Playback)		
During Ensemble song playback, the Ensemble parts cannot be heard.	Make sure that the audio cables between the Disklavier's audio OUTPUTS and the amp/speaker inputs are connected properly.	See "Connecting a Speaker System" on page 12 of the <i>Getting Started & Playback Manual</i> .
	Make sure that the amp's volume control is set to an appropriate level.	
	Readjust the volume balance.	See "Balancing the Ensemble Volume" on page 27 of the <i>Getting Started & Playback Manual</i> .

Chapter 13

Display Error Messages

The pitch of the Disklavier and internal XG tone generator do not match.	Use the TG Master Tune function to tune the internal XG tone generator.	See "Tuning the Tone Generator" on page 46 of the <i>Getting Started & Playback Manual</i> .
The TG Master Balance function does not adjust the volume of the internal XG tone generator.	Make sure that the BALANCE parameter is set to OFF.	See "Balancing the Ensemble Volume" on page 27 of the <i>Getting Started & Playback Manual</i> .
Recording		
You cannot record songs onto the internal Memory Disk.	Check that a floppy disk is not inserted in the disk drive when recording. If a floppy disk is inserted in the disk drive when recording, the Disklavier automatically records onto the floppy disk and not the internal Memory Disk.	
When recording the second part of an L/R song, the first part will not play back for monitoring.	Set the Monitor Piano option to ON.	See "Re-Recording One Part" on page 21 of the <i>Advanced Operation Manual</i> .
When recording a new part to an existing track, the new part replaces the existing parts.	Set the Record Tr option to OVERDUB.	See "Overdubbing a Track" on page 30 of the <i>Advanced Operation Manual</i> .
You cannot re-record.	Re-recording is not possible on protected disks such as PianoSoft and PianoSoft-Plus disks.	
Connection with External Devices		
The Disklavier cannot send and receive MIDI data with other MIDI instruments.	Make sure the MIDI cables are connected properly.	
A MIDI loop was accidentally created when you connected a computer to the MIDI OUT connector on your Disklavier, so that song data is sent back and forth between the computer and piano.	Set MIDI Out to KBD Out.	See Chapter 9, "The Disklavier & Computers" in the <i>Advanced Operation Manual</i> .
Disk Utilities		
You cannot copy a song in the Memory Disk onto a floppy disk.	Copy-protected songs in the Memory Disk cannot be copied onto a floppy disk. They can only be copied onto the Memory Disk. Make sure that the floppy disk's erasure tab is set to "unprotected".	See "Accidental Erasure Protection" on page 2 of the <i>Advanced Operation Manual</i> .

While operating your Disklavier an error message may appear in the display. If an error message does appear, look in the table below for an explanation of the message.



Note: This table does not explain every error message.

CANNOT RE-RECORD PROTECTED FILE	PianoSoft songs cannot be re-recorded, as they are write-protected.
CANNOT EXECUTE. PROTECTED FILES EXIST	The current function cannot be executed because protected files exist on the floppy disk.
DISK FULL! INSERT ANOTHER DISK	No more song data can be recorded onto the floppy disk because the disk is full. Use another floppy disk.
DISK WRITE PROTECTED!	The current function cannot be performed because the floppy disk's erasure protection tab is set to "protected". Set the disk's erasure protection tab to "unprotected". See "Accidental Erasure Protection" on page 2 in the <i>Advanced Operation Manual</i> .
NOT ENOUGH DISK SPACE	No more song data can be recorded onto the disk because the disk is nearly full.
CANNOT RECORD MORE THAN 60 SONGS	No more than 60 songs can be recorded onto an E-SEQ type disk.
CANNOT RECORD MORE THAN 99 SONGS	No more than 99 songs can be recorded onto an SMF type disk.
SONG FILE NOT FOUND	The current function cannot be performed because this disk contains no songs or only one song.
WRONG DESTINATION DISK	A wrong floppy disk has been inserted as the destination disk. Insert the correct floppy disk.
UNFORMATTED DISK	The floppy disk is either new and has not yet been formatted for use with the Disklavier or it uses a format not recognized by the Disklavier. Format the floppy disk. See "Formatting Disks" on page 2 in the <i>Advanced Operation Manual</i> .
UNSUITABLE DISK FORMAT	The destination disk must be the same format as the floppy disk to be copied.

Chapter 14 Glossary

SELECT REC TRACK!	You must select the track you want to record before starting recording.
ONLY E-SEQ FILES CAN BE COPIED	Only E-SEQ files can be recorded onto an E-SEQ type disk.
ERROR HAS OCCURRED! (PRESS STOP KEY!)	The floppy disk may be damaged. Press the Stop key to clear the message. If this message appears frequently with other disks as well, contact your nearest Yamaha service representative.

This glossary provides basic definitions of terms used frequently in the Disklavier manuals.

Auto Start	: A Disklavier function that automatically starts song playback when the power is switched on.
bpm	: An abbreviation for beats per minute
Clavinova™	: A series of Yamaha digital pianos.
Continuous Pedal	: Same as “Incremental Pedal”.
Cursor	: The “ ” symbol that is used on the LCD to show the currently selected function or option. When entering song or disk titles, the cursor will be the “_” symbol. Do not confuse this with the [] [] cursor buttons.
Dial	: The rotary control on the Control Unit used to adjust the volume, set parameters and options.
Disk	: Storage media for data. For clarity in the Disklavier manuals, “disk” is used as a generic term to refer to both the floppy disk and internal Memory Disk. All Disklavier playback, recording, and disk utility functions can be used for both the internal Memory Disk and floppy disks.
Ensemble Song	: A song which contains piano parts and accompanying instrumental voices. An Ensemble song contains the same left and right-hand parts as an L/R song, and in addition, up to 13 accompanying instrument tracks. These extra tracks are played by the internal XG tone generator. The accompanying tracks may be used for acoustic bass, drums, strings, vibes, etc.
E-SEQ Song Format	: A song file format developed by Yamaha for saving songs onto floppy disk.
E-SEQ Type Disk	: One of two disk types that the Disklavier uses to format disks. E-SEQ type disks are compatible with earlier Disklavier models.
Fast Forward & Reverse	: Two Disklavier functions that allow you to quickly locate a position within a song. This is faster than preview and review, but the Disklavier does not play.
Fast Preview & Review	: Two Disklavier functions that allow you to search quickly through a song with the Disklavier playing.
Floppy Disk	: The magnetic storage medium that the Disklavier uses to save songs. The Disklavier uses the 3.5 inch 2DD and 2HD floppy disks commonly used for computers.

Formatting	: New floppy disks must be formatted before they can be used with the Disklavier. Formatting prepares the disk so that it is ready to store Disklavier song data.
General MIDI (GM)	: An addition to the MIDI standard that simplifies the transfer of MIDI song files between different manufacturers' instruments. A MIDI song recorded using a GM compatible tone generator should play back correctly when used with any GM compatible tone generator. The standard specifies that a GM compatible tone generator must support 24-note polyphony, 16 parts, and 128 standard voices.
Half Pedal	: Same as "Incremental Pedal".
Import File	: Songs recorded onto floppy disks using MIDI equipment other than the Disklavier and played back by the Disklavier.
Incremental Pedal	: Piano pedals are not always fully up or down; they may be held somewhere in-between. The Disklavier can record and play back pedal movements of the left and right pedals, and this is called incremental or continuous pedal data (half data).
LCD	: Liquid Crystal Display. The Control Unit has a 2-line, 24-character LCD. For clarity in the Disklavier manuals, the LCD is referred to as the "display".
LED	: Light Emitting Diode. The Control Unit's front panel indicators are LEDs.
L/R Song	: In a L/R song, the left-hand piano part is stored on track 1 (L) and the right-hand piano part is stored on track 2 (R). During playback you can cancel either part, and then play that part yourself. When recording an L/R song, you can record the two parts simultaneously or separately.
Memory Disk	: The Disklavier has an internal Memory Disk that allows you to store song data without a floppy disk. It has a memory capacity of 1MB.
Metronome	: A built-in device designed to mark exact time by a regularly repeated click and flashing of LED, and used for both recording and playback.
MIDI	: An acronym for Musical Instrument Digital Interface. MIDI allows electronic musical instruments to communicate with each other.
Overdub	: To add to an existing recording. For example, the Disklavier's rhythm track can be overdubbed. First record a bass drum, then a snare, then some hi-hats, etc.
Piano Parts	: Refers to the left- and right-hand piano parts of a song. The left-hand piano part is recorded onto track 1 and the right-hand piano part is recorded onto track 2 (default). This track assignment can be changed.
PianoSoft™	: The PianoSoft Disk Collection is a library of prerecorded song disks made by Yamaha, specifically for use with the Disklavier.
PianoSoft-Plus™	: PianoSoft-Plus disks contain Ensemble songs that can be played on the Disklavier.

Polyphony	: Ability of a musical instrument to play more than one note at a time. The Disklavier has 16-note polyphony. (The internal XG tone generator is capable of 32-note polyphony.)
Program Change Message	: A type of MIDI message that is used for selecting programs or voices. When an Ensemble song starts playing, Program Change messages are sent to the tone generator to select the correct instrument voices for each ensemble track.
Quantize	: A Disklavier function that can be used when recording. With the quantize function on, the timing of notes played using the Disklavier keyboard will automatically be corrected to the specified quantize value.
Rhythm Track	: Tracks of an ensemble song designated for the accompanying rhythm. The rhythm track is unaffected by the playback transposition function.
Search	: A Disklavier function that allows you to start playback from a specific point within a song. This function is set using the remote control.
Sequencer	: A sequencer can be used with the Disklavier to play back and record MIDI data.
SMF	: Abbreviation for Standard MIDI File.
SMF Song Format	: A song file format supported by MIDI sequencers and music software.
SMF Type Disk	: One of two disk types that the Disklavier uses to format disks. SMF type disks automatically record songs using SMF format 0.
Soft Mode	: A volume setting for the Disklavier upright, in the range -7 to -10. In this mode, the volume is reduced and the soft pedal mechanism is activated.
Song	: Normally, a short piece of music with lyrics. However, for clarity in the Disklavier manuals, the term is used to refer to any piece of music, be it jazz, classical, or popular.
Song Format	: The method used to store song data in a file. PianoSoft and PianoSoft-Plus songs use the E-SEQ format. The Disklavier also supports songs in the Standard MIDI File (SMF) format.
Song Number	: All songs on a Disklavier disk are numbered sequentially. The currently selected song number is shown in the Control Unit's Song Number Indicator. Songs can be selected directly by entering the song number using the remote control's number pad.
Song Sort	: A Disklavier function that allows you to rearrange the order of songs on a disk.
Space Playback	: A Disklavier function that allows you to specify a pause time between songs during playback.

Chapter 15

Disklavier Mark II XG Series

Specifications

- Split Point** : When a keyboard split point is set before recording, notes played on the left-hand side of the split point are saved as the left-hand part and notes played on the right-hand side of the split point are saved as the right-hand part. This allows you to play the left- and right-hand parts simultaneously, but on different tracks.
- Standard MIDI File (SMF)** : A file of MIDI data that can be read and used by a number of different MIDI devices and computers. The Disklavier supports all SMF playback functions.
- System Exclusive Messages** : A type MIDI messages that is used for sending system data to a connected MIDI device. For example, when tuning the internal XG tone generator or an external tone generator, System Exclusive Messages are sent via MIDI.
- TG Master Balance** : A function that allows you to balance the volume levels of the Disklavier and the internal XG tone generator.
- TG Master Tune** : The function that allows you to tune the internal XG tone generator, and if connected, an external tone generator simultaneously so that their tunings match that of the Disklavier.
- Tone Generator** : An electronic device that can generate tones or instrument voices.
- Track** : Disklavier ensemble song data is organized as tracks. One song can be composed of up to 16 tracks.
- Transpose** : Changing the key of a song. For example, a song in the key of C can be transposed to the key of D by transposing it up two semitones.
- Velocity** : Because the loudness of a piano note is determined by the speed (velocity) with which a string is struck by a hammer, note loudness is referred to as velocity.
- Voice** : The sounds produced by a tone generator expressing various instruments. See the "Internal XG Tone Generator Voice & Drum Kit List" on pages 51 and 52 of the *Getting Started & Playback Manual* for a listing of capital voices, and the Appendix "MIDI Data Format" at the very end of this manual for a full listing of available voices.
- XG** : Yamaha XG is an extension of the GM (General MIDI) format. It has greater polyphony, more voices, and incorporates effects, enhancing the compatibility between MIDI devices. When a song in the Yamaha XG format is played on another XG-compatible tone generator or synthesizer, it plays and sounds as the original composer/creator intended.

Sensor System	Action	Speed sensing, single-beam optical sensors Dual key/hammer locations 16-note polyphonic	
	Pedals	Sustain	Incremental, position sensing optical sensors
		Shift (Soft)	
	Sostenuto ¹	On/off sensor	
Drive System	Keys	Self-calibrating, long-stroke, key-end solenoids 16-note polyphonic	
	Pedals	Sustain	Trapwork integrated solenoids; incremental response
Shift (Soft)			
Data Storage	Media	3.5" 2DD (720KB) or 2HD (1.44MB) floppy disk	
	Memory Disk	Flash memory (1MB)	
	File Format	E-SEQ/Standard MIDI File (format 0, format 1)	
Control Unit	Main Display	24-character × 2-line LCD	
	Song # Indicator	7-segment, 2-digit LED	
	Function Indicators	LEDs	
	Switches	Power, Host Select (MIDI/PC1/PC2/Mac)	
	Connectors	MIDI (In, Out), Audio Output (R, L/Mono), To Host (Serial Port), To Piano	
	Dimensions (W × H × D)	316 × 60 × 209 mm (12½" × 2½" × 8¼")	
	Weight	2.0 kg (4.4 lbs.)	
	Tone Generator	Type	Advanced Wave Memory 2 (AWM2)
Polyphony		32-note max.	
Ensemble Parts		16	
Voice Module Modes		XG, GM	
Normal Voices		676 (480 selectable)	
Drum Voices		21 kits total (11 selectable)	
Pitch		Set at A=440, tunable ±50 cents in 1 cent steps w/power-off memory	
Metronome	Range	30 to 400 beats per minute	
	Time Signatures	1/4, 2/4, 3/4, 4/4, 5/4, 6/4, 7/4, 8/4, 9/4	
	Function	Audible (clck, on/off), visual (LEDs)	
Other Equipment		Mains switch, foot controller connector	
Power Source		Local AC current	
Playback Functions	Volume	11 levels (0~–10) w/power-off memory	
	Tempo	–50% ~ +20% in 1% steps	
	Transposition	±24 semitones (2 octaves) in 1 semitone steps	
	Balance	Balancing volume of Ensemble voices and piano	
	Repeat ²	Disk, song, random, segment A-B, segment A-	
	Song Select	REV/FWD, song by song; numerical selection	
	Music Search	REV/FWD, w/ or w/o sound; direct by time or measure	
	Others	L/R Part Select, Auto Start, Space Playback, Pedal Cancel, Pedal Count-in	

Recording Functions	Tracks	16 (including 2 for piano)	
	L/R Dual Recording	Separate L/R or assignable split point	
	Quantize	1/4, 1/6, 1/8, 1/12, 1/16 of a quarter note	
	Others	Re-recording	
Editing Functions	Tracks	Mix, move, copy, delete, transpose	
Utility Functions	Song	Copy, sort, delete, type convert (SMF, E-SEQ, earlier Disklavier), time format convert	
	Disk	Format, copy, type convert	
	Title Entry	Disk	64 characters max.
		Song	32 characters max.
Supplied Accessories		Wireless remote control unit w/batteries PianoSoft sample disk, Blank 3.5" 2DD floppy disk, Owner's manuals, Control unit suspension bracket ³	
Optional Accessories		FC-4/FC-5 Foot switch (on/off, w/1.7m cable) FC-7 Foot controller (variable, w/1.7m cable)	

Specifications are subject to change without notice.

- Note: 1. Not applicable to models with other center pedal functions.
2. Remote control only.
3. Grand models only.